

Assembly Instruction

## Rivenn Leather Recliner and Ottoman







# Welcome Guide

[www.sohnne.com](http://www.sohnne.com)

# Assembly Instruction

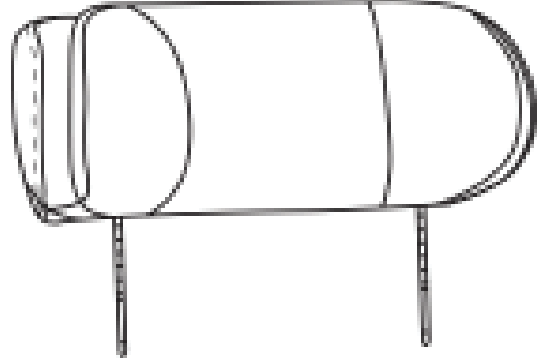
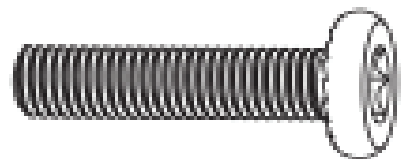
Box 1 :

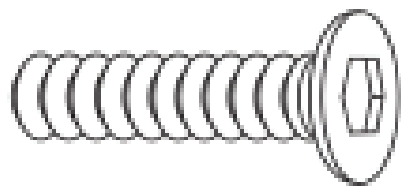
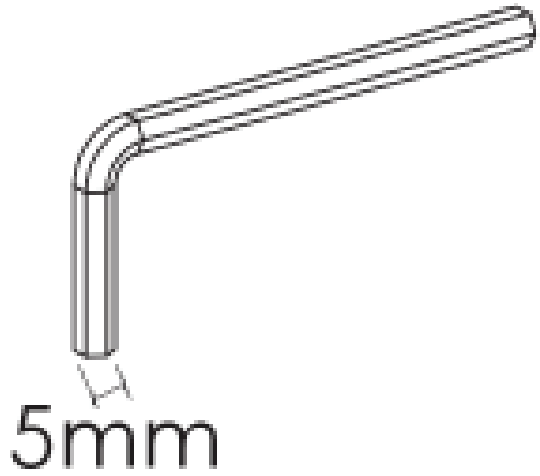
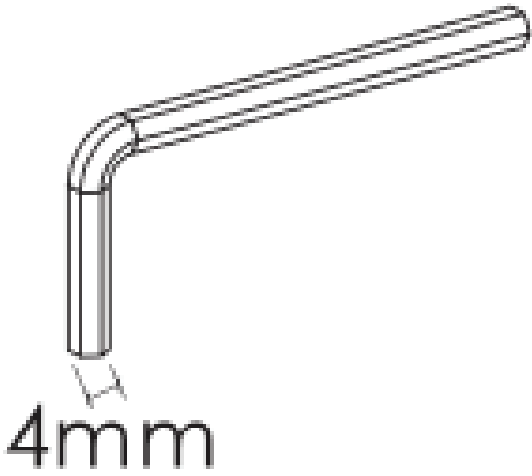
B1×1  Chair Body	B2×1  Ottoman Body	C1×1  Headrest
H1×4  Bolt (M6x25mm)	H2×4  Spring Washer (M6)	H3×4  Flat Washer (M6)
H4×4  Bolt (M6x25mm)	T1×1  Allen Wrench (M5)	T2×1  Allen Wrench (M4)

Box 2 :

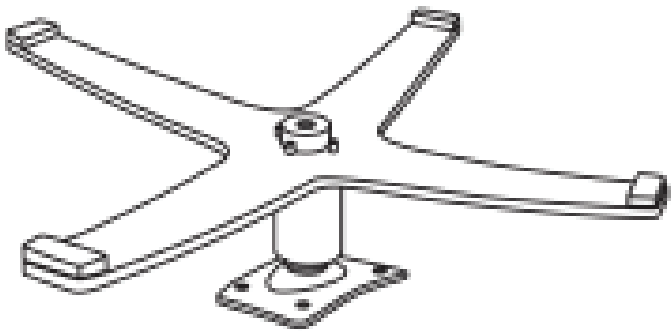
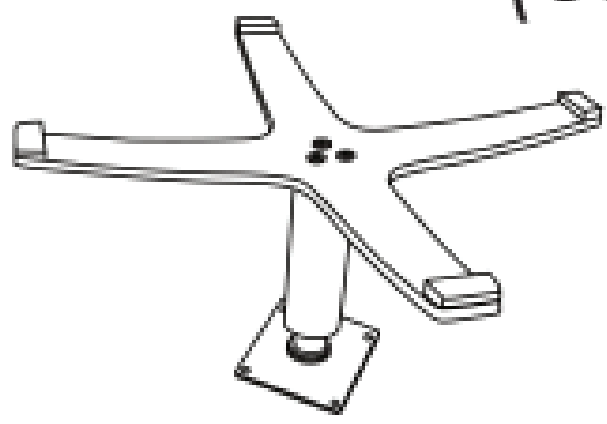
A1×1  Chair Base	A2×1  Ottoman Base	
---	--	--

- 
- 1** Attach the Chair Base (A1) to the Chair Body (B1) using Bolts (H1), Spring Washers (H2), Flat Washers (H3) and Wrench (T1).

**Note: Please pay attention to the direction of the Chair Base (A1). The higher end of the metal plate on the Chair Base (A1) should face the front of the chair and the lower end should face the back.**

**Note: Do NOT use power tools for assembly.**

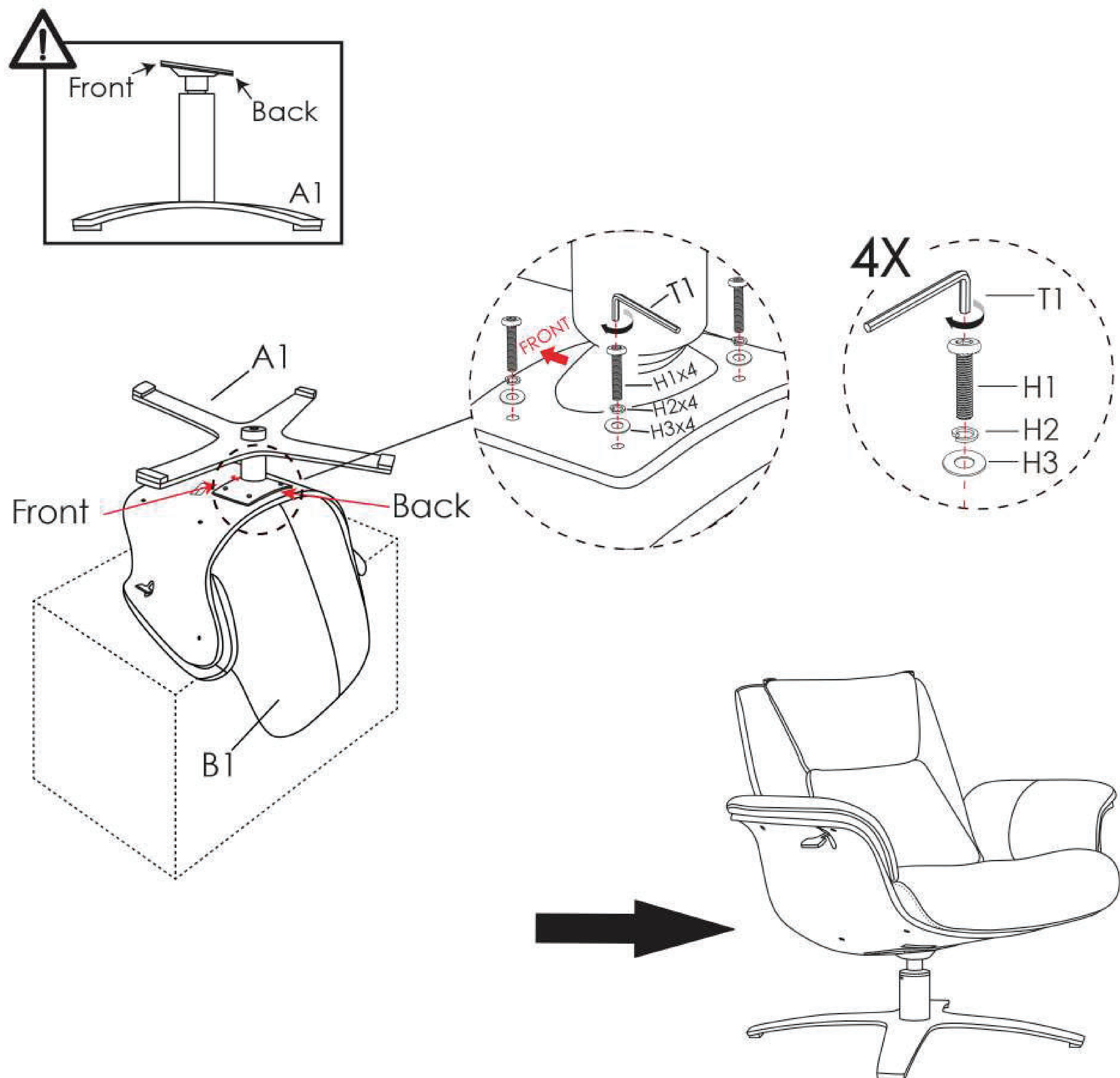

- 
- 3** Insert the Headrest (C1) into the Chair Body (B1).

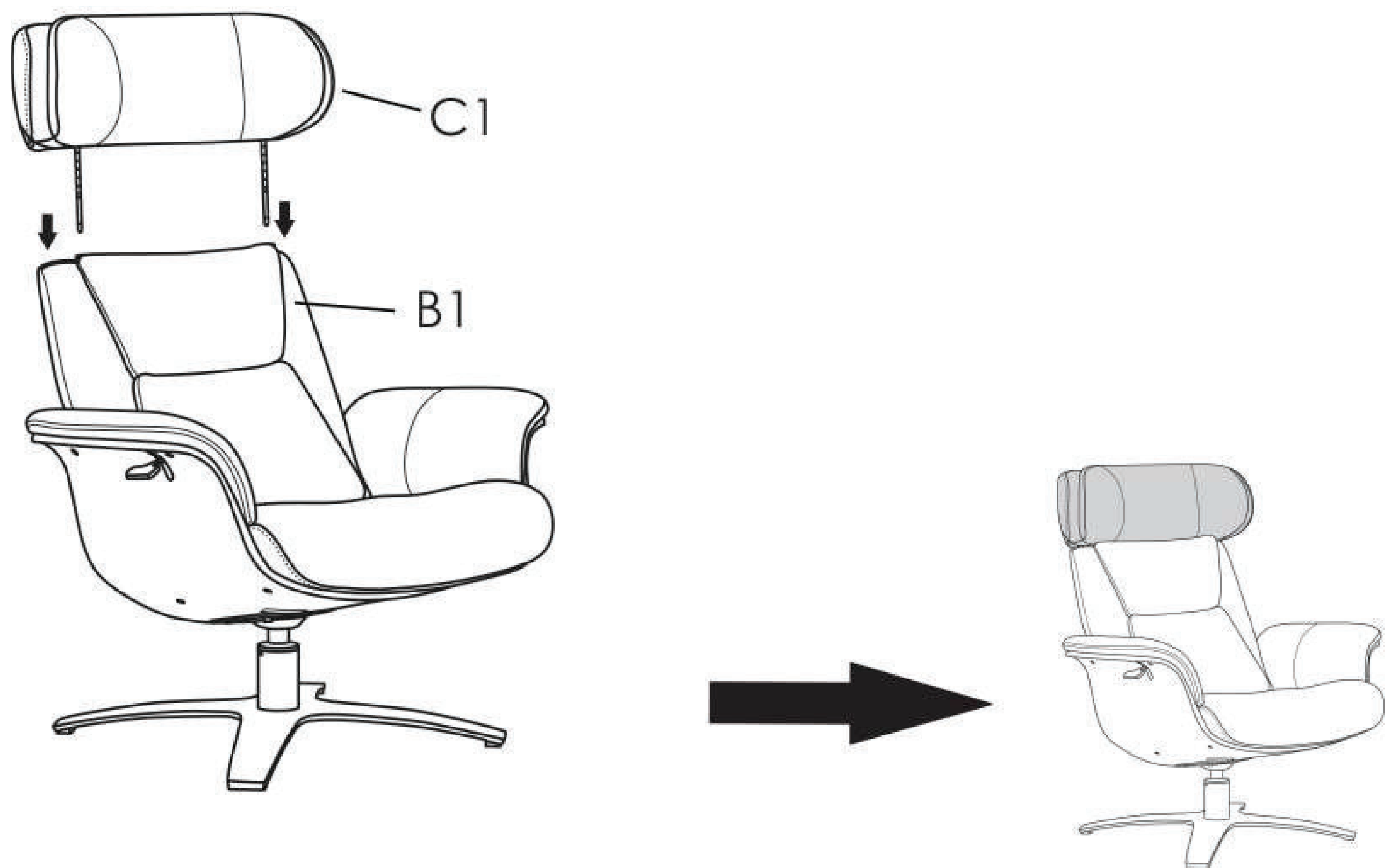

- 4** Unpack and place the Ottoman Body (B2) on a soft, clean surface. Attach the Ottoman Base (A2) to the Ottoman Body (B2) using Bolts (H4) and Allen Wrench (T2).

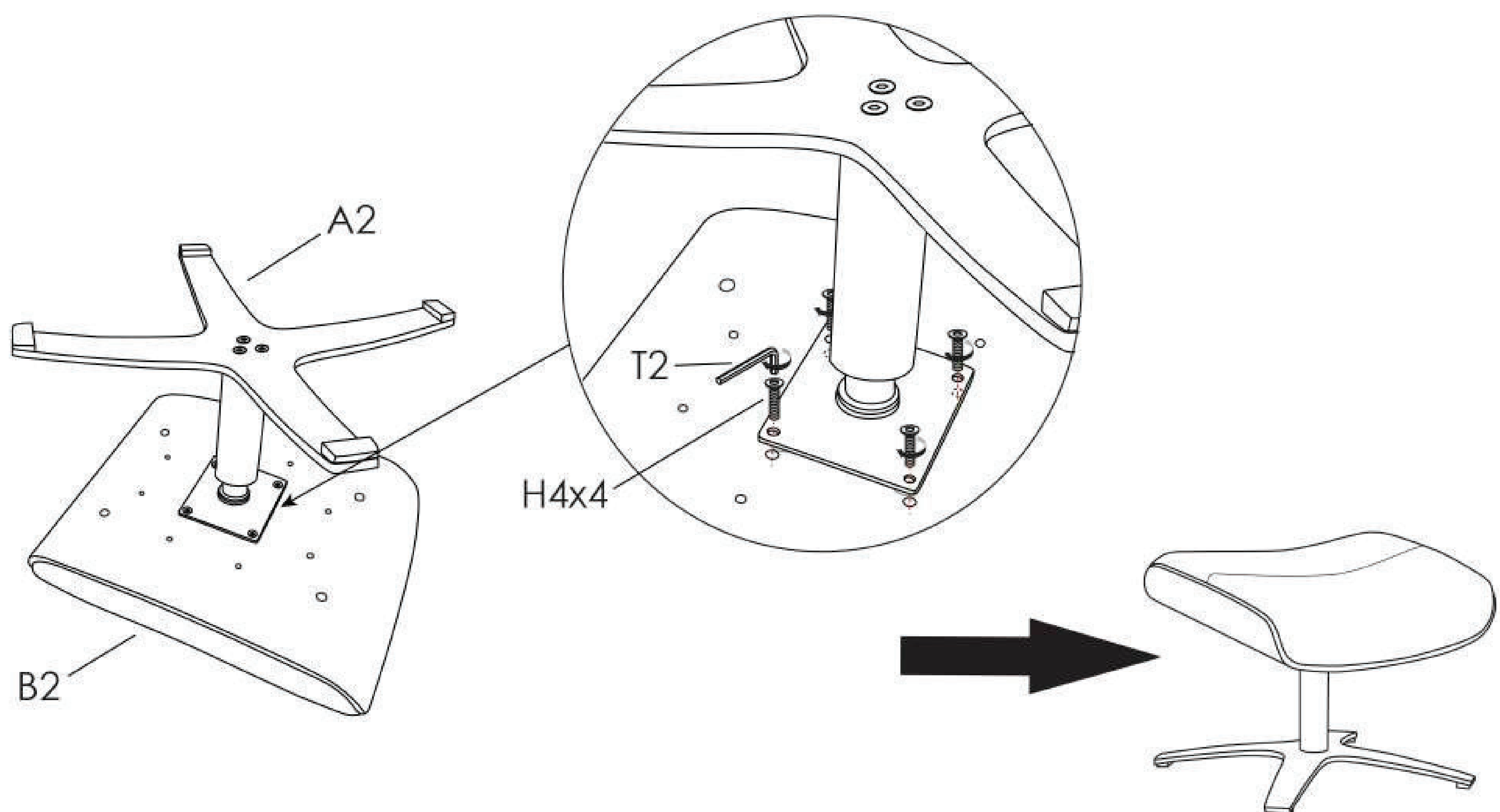

---

**5** Assembly complete. Enjoy.



## How to adjust the headrest?

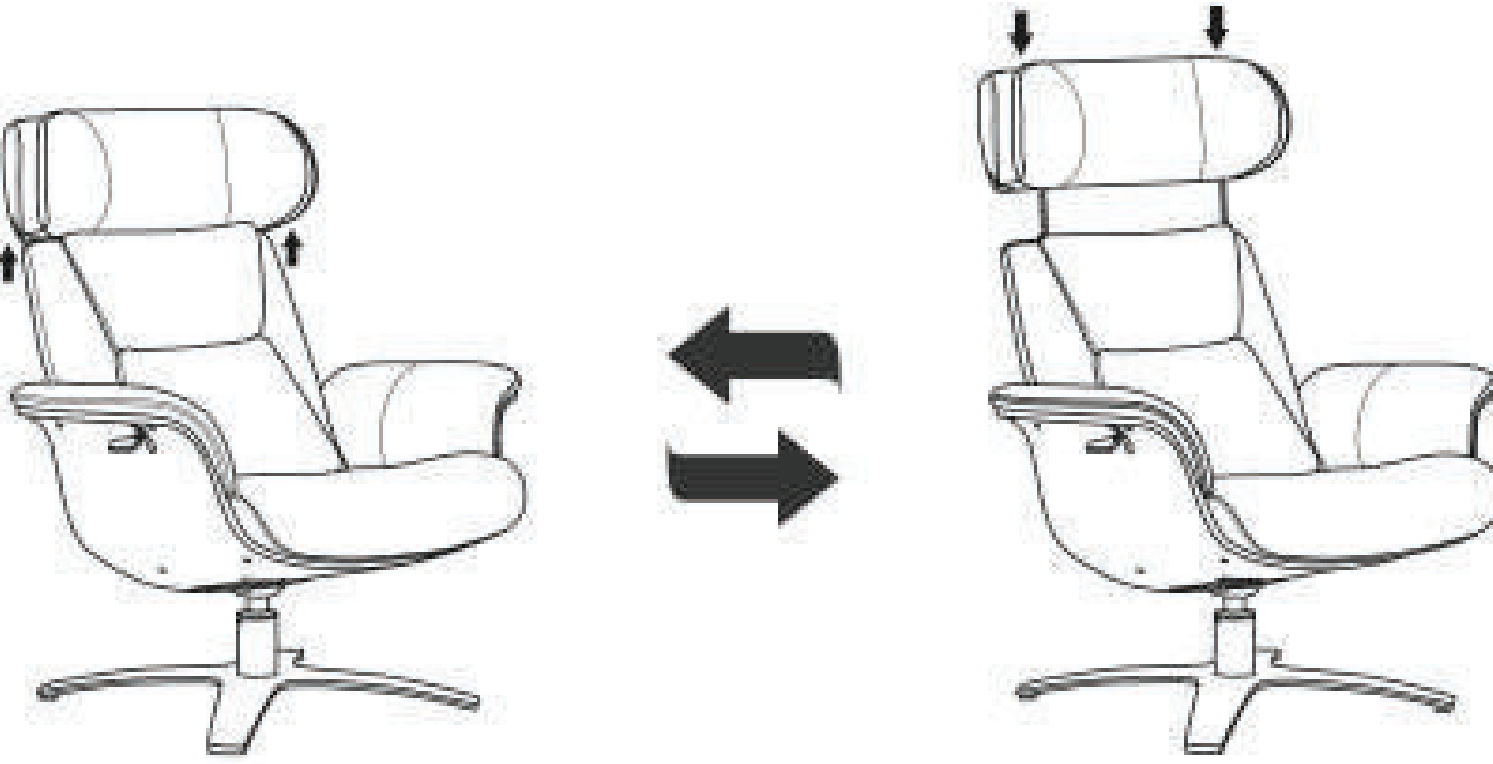

- Lift or lower the headrest to accommodate different heights.



**Push Forward**

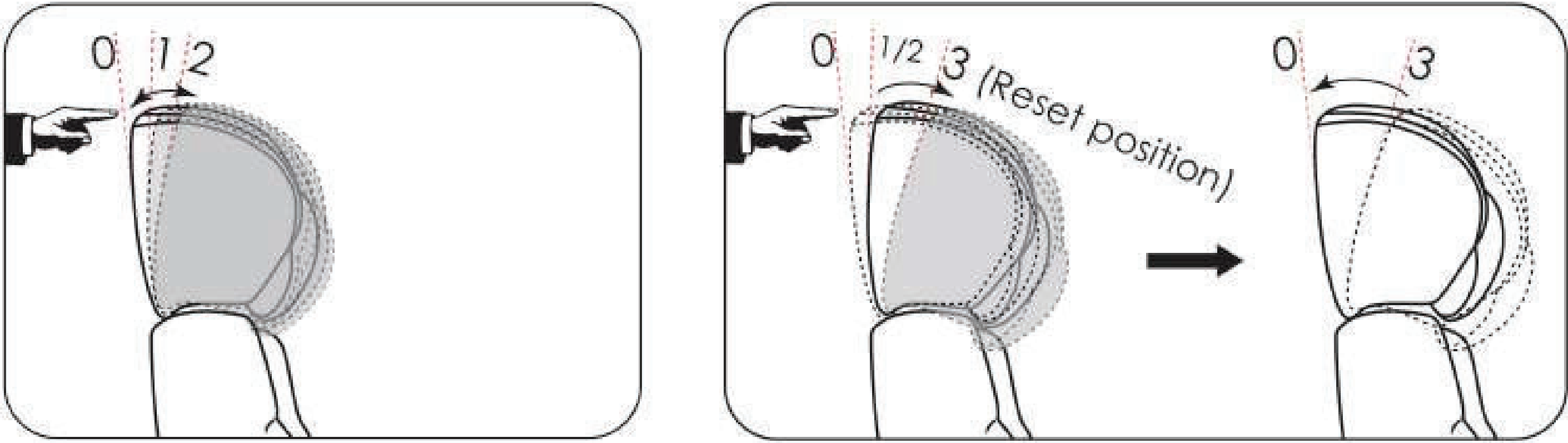

- The headrest has 3 different positions: Position 0 (original position), Position 1, Position 2. Push the headrest forward slightly to get to Position 1 and Position 2.
- Reset: Push the headrest further forward to Position 3, the headrest will then be released to Position 0.

## How to adjust the backrest?

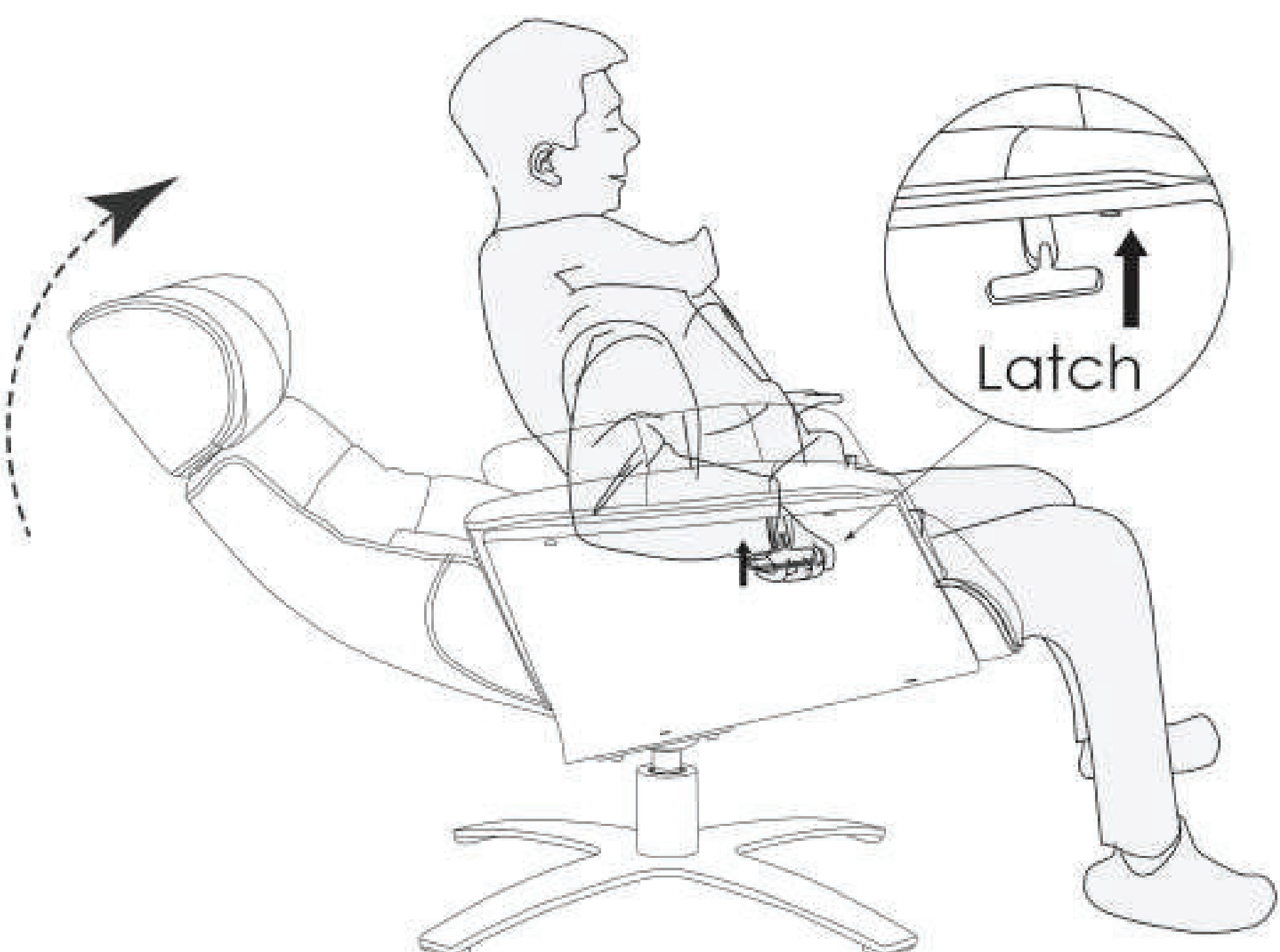
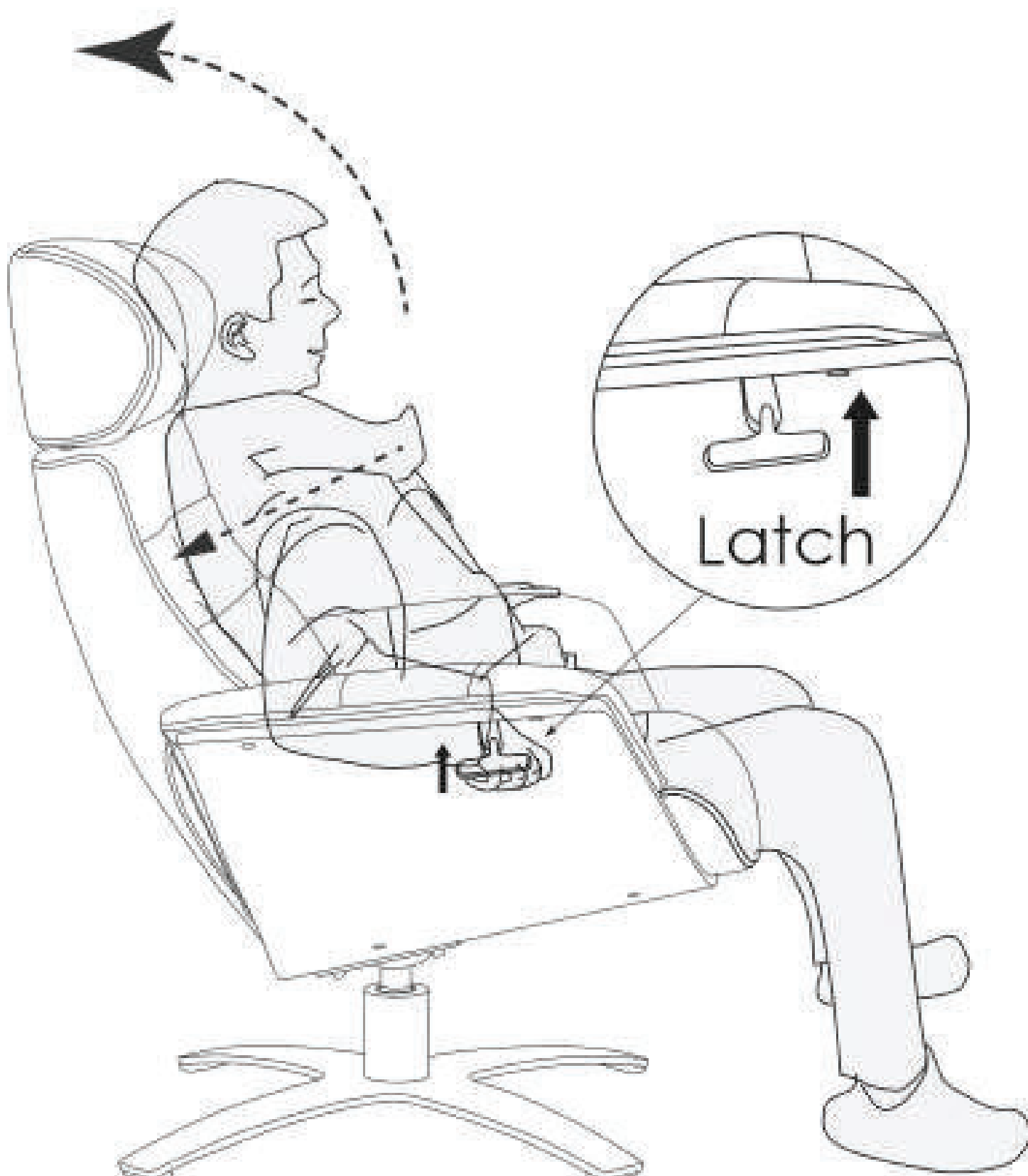

- 1) From **Upright Position** to **Fully Reclined Position**: Lift the latch to recline.
- 2) From **Fully Reclined Position** to **Upright Position**: Sit up slightly. Lift the latch and the backrest will move forward to upright position.

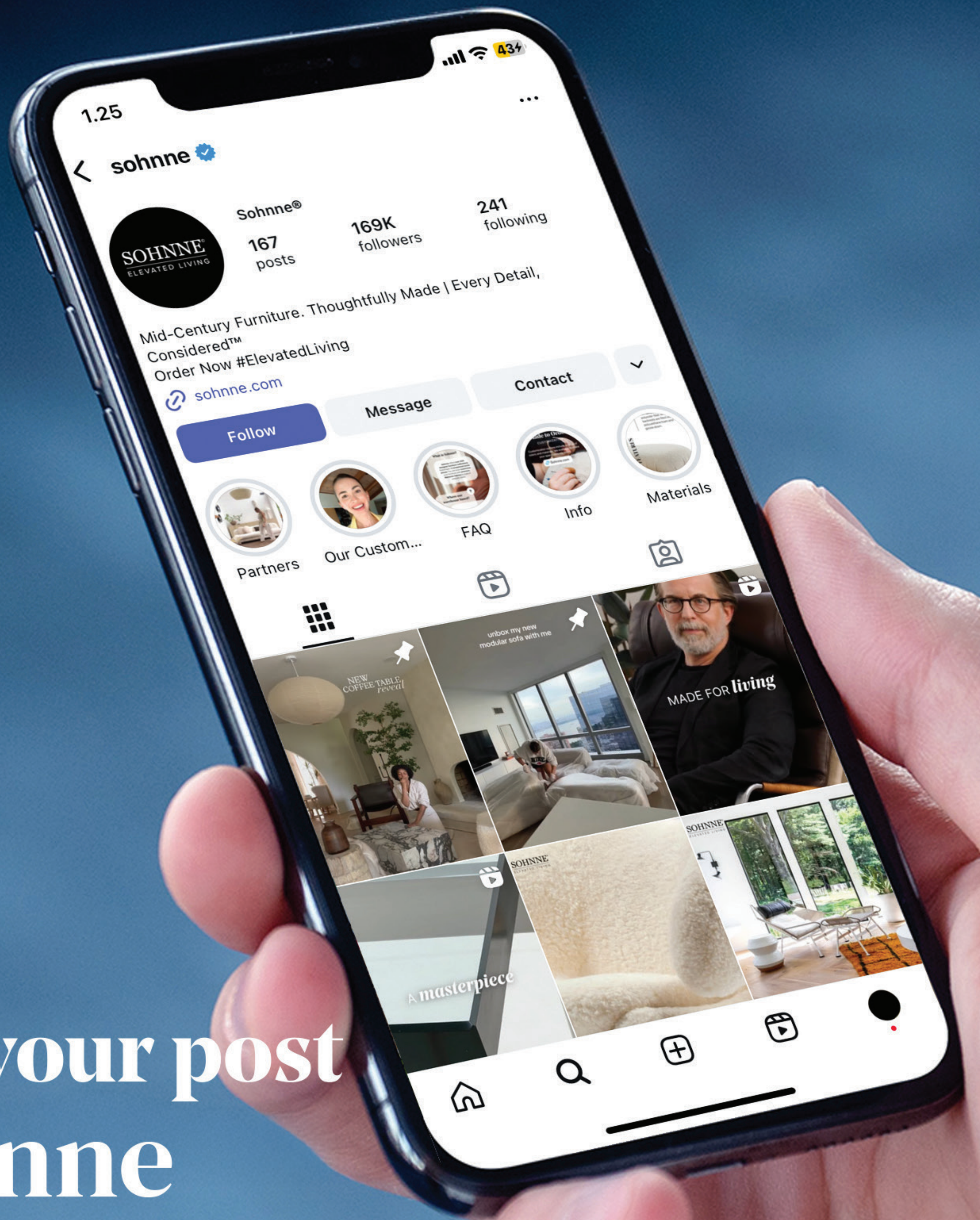

# Tag in your post @sohnne



\$50 off for photo review



\$100 off for video review

**SOHNNE**<sup>®</sup>  
ELEVATED LIVING